

### CH Varistor Series



CH series transient surge suppressors are small, metal-oxide varistors (MOVs) manufactured in leadless chip form. They are intended for use in a variety of applications from low voltage DC to off-line board-level protection. These devices, which have significantly lower profiles than traditional radial-lead varistors, permit designers to reduce the size and weight and increase the reliability of their equipment designs.

CH series varistors are available in a voltage range from 14V to 275V  $V_{M(AC)RMS}$ , and energy ratings up to 23J.

See the Littelfuse Multilayer Suppressor Series also.

#### Features

- Leadless, Surface Mount Chip in 5 x 8mm Size
- Voltage Ratings  $V_{M(AC)RMS}$ : .....14V to 275V
- Supplied in Tape and Reel or Bulk Pack
- No Derating up to 125°C Ambient

**AGENCY APPROVALS:** Recognized under the components program of Underwriters Laboratories.

**AGENCY FILE NUMBERS:** UL E75961, E135010.

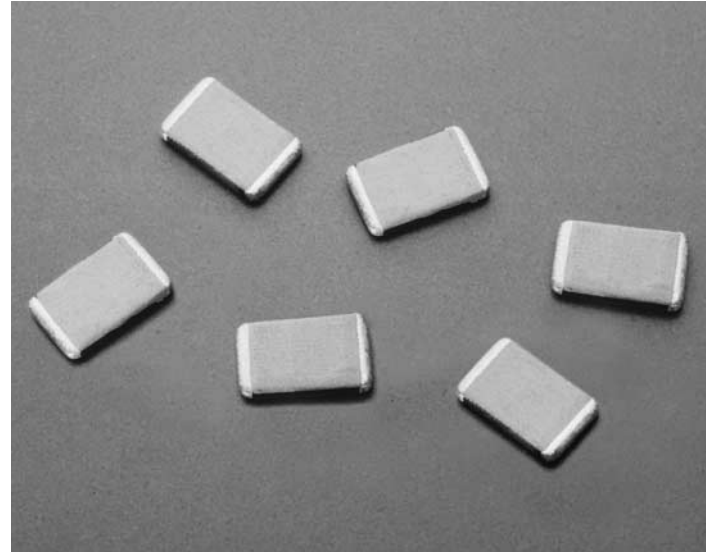

3  
SURFACE MOUNT  
VARISTORS

# Surface Mount Varistors

## Transient Voltage Surge Suppressor

### CH Varistor Series

**Absolute Maximum Ratings** For ratings of individual members of a series, see Device Ratings and Specifications chart

	CH SERIES	UNITS
Continuous:		
Steady State Applied Voltage:		
AC Voltage Range ( $V_{M(AC)RMS}$ )	14 to 275	V
DC Voltage Range ( $V_{M(DC)}$ )	18 to 369	V
Transient:		
Peak Pulse Current ( $I_{TM}$ )		
For 8/20 $\mu$ s Current Wave (See Figure 2)	250 to 500	A
Single Pulse Energy Range		
For 10/1000 $\mu$ s Current Wave ( $W_{TM}$ )	1.0 to 23	J
Operating Ambient Temperature Range ( $T_A$ )	-55 to 125	$^{\circ}$ C
Storage Temperature Range ( $T_{STG}$ )	-55 to 150	$^{\circ}$ C
Temperature Coefficient ( $\alpha_V$ ) of Clamping Voltage ( $V_C$ ) at Specified Test Current	<0.01	%/ $^{\circ}$ C

*CAUTION: Stresses above those listed in "Absolute Maximum Ratings" may cause permanent damage to the device. This is a stress only rating and operation of the device at these or any other conditions above those indicated in the operational sections of this specification is not implied.*

### Device Ratings and Specifications

PART NUMBER	MAXIMUM RATINGS (125 $^{\circ}$ C)				SPECIFICATIONS (25 $^{\circ}$ C)					
	CONTINUOUS		TRANSIENT		VARISTOR VOLTAGE AT 1mA DC TEST CURRENT			MAX CLAMPING VOLT $V_C$ AT TEST CURRENT (8/20 $\mu$ s)		TYPICAL CAPACITANCE
	$V_{RMS}$	$V_{DC}$	ENERGY (10/1000 $\mu$ s)	PEAK CURRENT (8/20 $\mu$ s)						
	$V_{M(AC)}$	$V_{M(DC)}$	$W_{TM}$	$I_{TM}$	MIN	$V_{N(DC)}$	MAX	$V_C$	$I_p$	f = 1MHz
	(V)	(V)	(J)	(A)	(V)	(V)	(V)	(V)	(A)	(pF)
V22CH8	14	18 (Note 3)	10.0 (Note 2)	250	18.7	22.0	26.0	47	5	1600
V27CH8	17	22	1.0	250	23.0	27.0	31.1	57	5	1300
V33CH8	20	26	1.2	250	29.5	33.0	36.5	68	5	1100
V39CH8	25	31	1.5	250	35.0	39.0	43.0	79	5	900
V47CH8	30	38	1.8	250	42.0	47.0	52.0	92	5	800
V56CH8	35	45	2.3	250	50.0	56.0	62.0	107	5	700
V120CH8	75	102	6.0	500	108.0	120.0	132.0	200	10	300
† V150CH8	95	127	8.0	500	135.0	150.0	165.0	250	10	250
† V180CH8	115	153	10.0	500	162.0	180.0	198.0	295	10	200
† V200CH8	130	175	11.0	500	184.0	200.0	228.0	340	10	180
† V220CH8	140	180	12.0	500	198.0	220.0	242.0	360	10	160
† V240CH8	150	200	13.0	500	212.0	240.0	268.0	395	10	150
† V360CH8	230	300	20.0	500	324.0	360.0	396.0	595	10	100
† V390CH8	250	330	21.0	500	354.0	390.0	429.0	650	10	90
† V430CH8	275	369	23.0	500	389.0	430.0	473.0	710	10	80

NOTES:

1. Power dissipation of transients not to exceed 0.25W.
2. Energy rating for impulse duration of 30ms minimum to one half of peak current value.
3. Also rated to withstand 24V for 5 minutes.

† V150 - V430 CH Varistors are recognized under UL file #E75961 as a recognized component.

### CH Varistor Series

#### Power Dissipation Ratings

Continuous power dissipation capability is not an applicable design requirement for a suppressor, unless transients occur in rapid succession. Under this condition, the average power dissipation required is simply the energy (watt-seconds) per pulse times the number of pulses per second. The power so developed must be within the specifications shown on the Device Ratings and Specifications table for the specific device. Furthermore, the operating values need to be derated at high temperatures as shown in Figure 1. Because varistors can only dissipate a relatively small amount of average power they are, therefore, not suitable for repetitive applications that involve substantial amounts of average power dissipation.

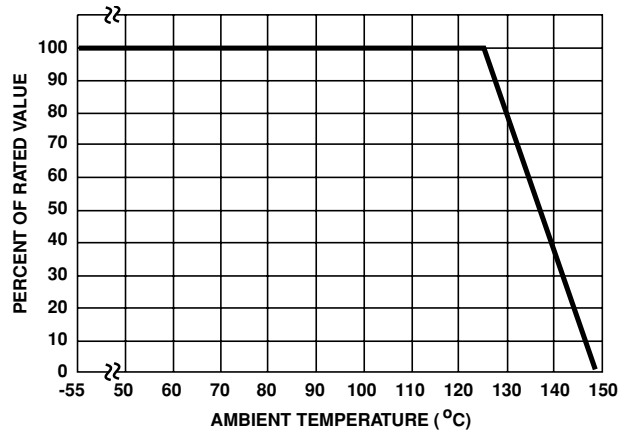
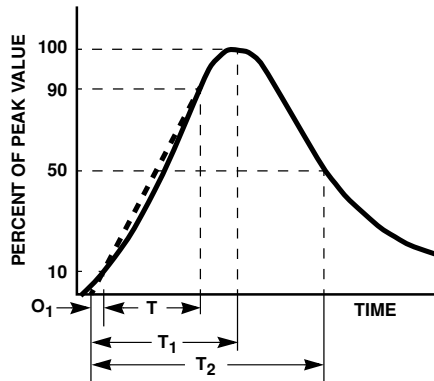

FIGURE 1. CURRENT, ENERGY AND POWER DERATING CURVE



$O_1$  = Virtual Origin of Wave  
 $T$  = Time From 10% to 90% of Peak  
 $T_1$  = Virtual Front time =  $1.25 \cdot t$   
 $T_2$  = Virtual Time to Half Value (Impulse Duration)  
 Example: For an 8/20 $\mu$ s Current Waveform:  
 $8\mu$ s =  $T_1$  = Virtual Front Time  
 $20\mu$ s =  $T_2$  = Virtual Time to Half Value

#### Transient V-I Characteristics Curves

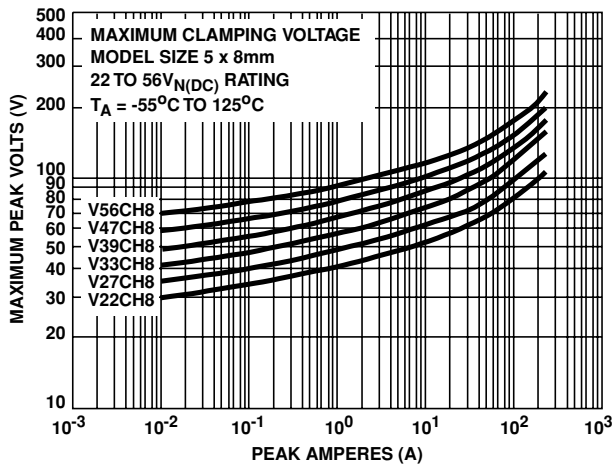

FIGURE 3. CLAMPING VOLTAGE FOR V18CH8 - V68CH8

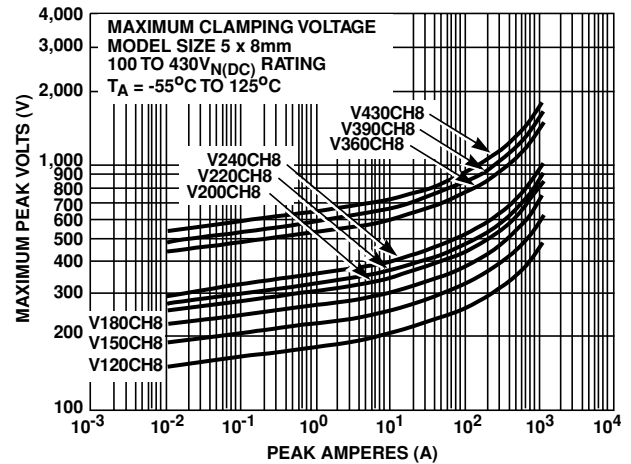

FIGURE 4. CLAMPING VOLTAGE FOR V82CH8 - V430CH8

### CH Varistor Series

#### Pulse Rating Curves

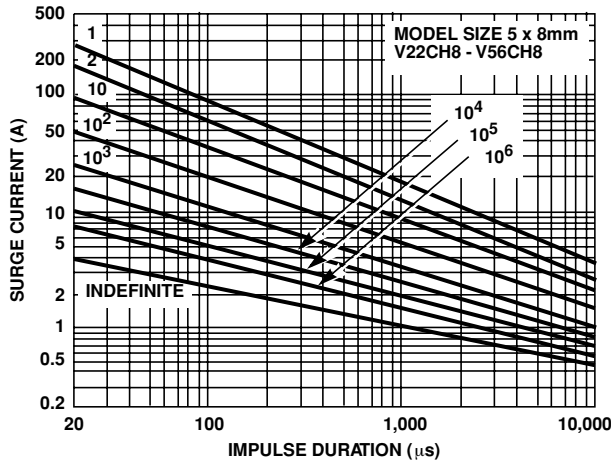

FIGURE 5. SURGE CURRENT RATING CURVES FOR V18CH8 - V68CH8

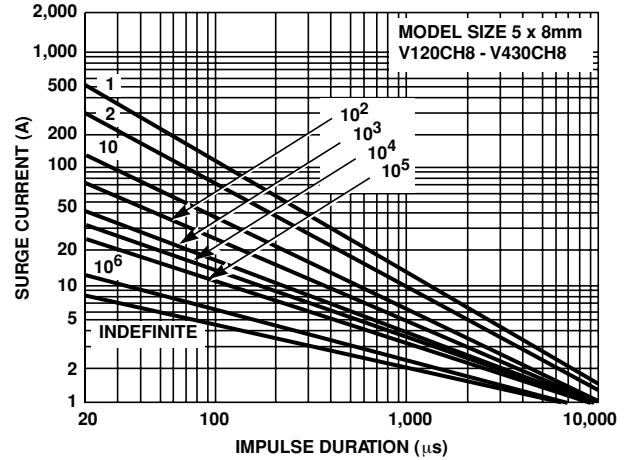
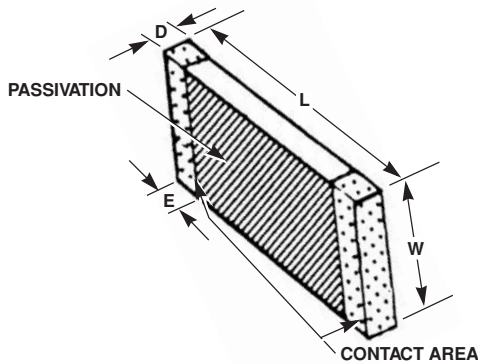

FIGURE 6. SURGE CURRENT RATING CURVES FOR V82CH8 - V430CH8

NOTE: If pulse ratings are exceeded, a shift of  $V_{N(DC)}$  (at specified current) of more than  $\pm 10\%$  could result. This type of shift, which normally results in a decrease of  $V_{N(DC)}$ , may result in the device not meeting the original published specifications, but it does not prevent the device from continuing to function, and to provide ample protection.

#### Mechanical Dimensions



SYMBOL	INCHES		MILLIMETERS	
	MIN	MAX	MIN	MAX
D	-	0.080	-	2.03
E	0.016	0.050	0.41	1.27
L	0.311	0.335	7.90	8.51
W	0.185	0.207	4.70	5.26

#### Recommended Pad Outline

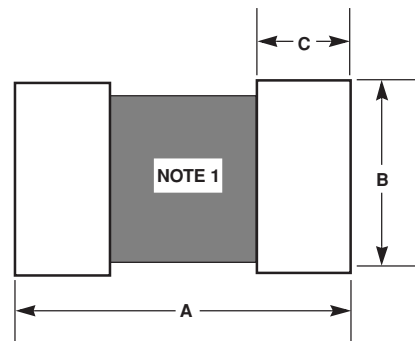

SYMBOL	INCHES	MILLIMETERS
A	0.402	10.21
B	0.216	5.50
C	0.087	2.21

NOTE: Avoid metal runs in this area. Soldering recommendations: Material - 62/36/2 Sn/Pb/Ag or equivalent. Temperature - 230°C Max., 5s. Max. Flux - R.M.A.

### CH Varistor Series

#### Standard Packaging

CH Series varistors are always shipped in tape and reel. The standard 13in reel utilized contains 4000 pieces.

Note also that the CH Series receives no branding on the chip itself.

#### Tape and Reel Specifications

- Conforms to EIA-481, Revision A
- Can be Supplied to IEG Publication 286-3

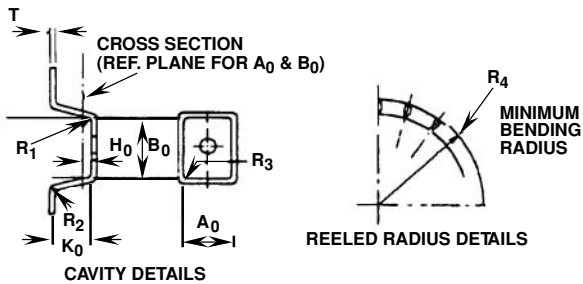
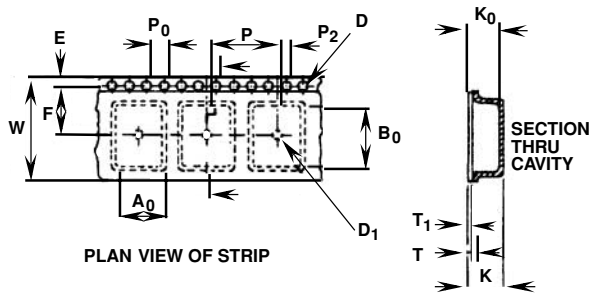

#### Special Packaging

**Option 1** - 7-inch reels containing 1000 pieces are available. To order 7in reels add a T suffix to the part number; e.g., V47CH8T.

**Option 2** - For small quantities (less than 100 pieces) the units are shipped bulk pack. To order, add a S suffix to the part number; e.g., V47CH8S.

SYMBOL	PARAMETER	SIZE (mm)
B <sub>0</sub>	Cavity Length	8.5 ± 0.1
A <sub>0</sub>	Cavity Width	5.5 ± 0.1
K <sub>0</sub>	Cavity Depth	2.0 Min.
H <sub>0</sub>	Ref. Plane for A <sub>0</sub> and B <sub>0</sub>	+0.10 0.3 -0.05
R <sub>1</sub> , R <sub>2</sub> , R <sub>3</sub>	Tape Cavity Radii	0.5 Max.
T	Carrier Tape Thickness	1.0 Max.
T <sub>1</sub>	Cover Tape Thickness	0.1 Max.
E	Sprocket Hole from Edge	1.75 ± 0.1
P <sub>0</sub>	Sprocket Hole Pitch	4.0 ± 0.1
D	Sprocket Hole Diameter	+0.1 1.5 -0.0
P <sub>2</sub>	Hole Centre to Component Centre	2.0 ± 0.15
R <sub>4</sub>	Min. Bending Radius	40.0 Min.
D <sub>1</sub>	Ejection Hole Diameter	1.5 Min.
K	Overall Thickness	3.0 Min.
P	Pitch Of Component	8.0 ± 0.1
F	Sprocket Hole to Ejection Hole	7.5 ± 0.1
W	Carrier Tape Width	16.0 ± 0.3

3 SURFACE MOUNT VARISTORS

#### Ordering Information

