

2

1

150, 130, 140 model
 All elements matched to demonstrate the validity of the model.
 S is the summing node of the power splitter/combiner.
 RXtop and RXbot feed the window comparators.
 TXtop and TXbot are driver op-amp outputs.

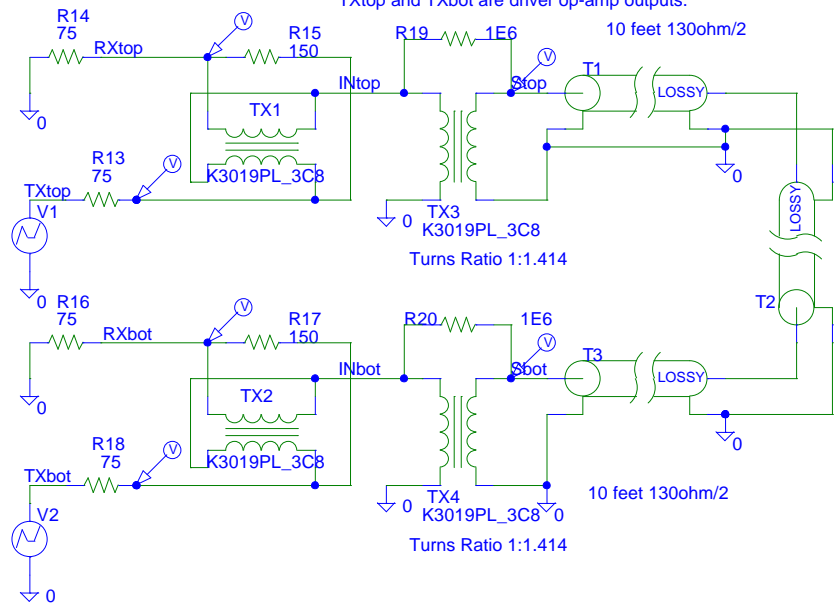

10 feet 130ohm/2
 50 feet 140ohm/2
 Length in meters,
 Capacitance in Farads,
 Inductance in Henries
 Zo=50=> {C=101.08pF/meter, L=252.7nH/meter}
 Zo=65=> {C=77.75pF/meter, L=328.51nH/meter}
 Zo=70=> {C=72.2pF/meter, L=353.78nH/meter}
 Zo=80=> {C=63.175pF/meter, L=404.32nH/meter}

B

B

A

A

2

1